















10 300 970

- Länge Kniehebel 185 mm

Nur für Becken mit Überlauf geeignet.



Passt zu: IMO, LULU, MADISON, MEM, TARA, CL.1, LISSÉ, VAIA, META, CYO

	Champagne gebürstet (22kt Gold)	10 300 970-46
	Chrom	10 300 970-00
	Platin gebürstet	10 300 970-06
	Platin	10 300 970-08
	Messing (23kt Gold)	10 300 970-09
	Dark Chrome	10 300 970-19
	Light Gold	10 300 970-26
	Light Gold gebürstet	10 300 970-27
	Messing gebürstet (23kt Gold)	10 300 970-28
	Schwarz matt	10 300 970-33
	Bronze gebürstet	10 300 970-42
	Champagne (22kt Gold)	10 300 970-47
	Chrom gebürstet	10 300 970-93
	Dark Platinum gebürstet	10 300 970-99

10 300 970



10 300 970

Ersatzteile für die
anderen
Oberflächenvarianten
finden Sie hier:
Chrom

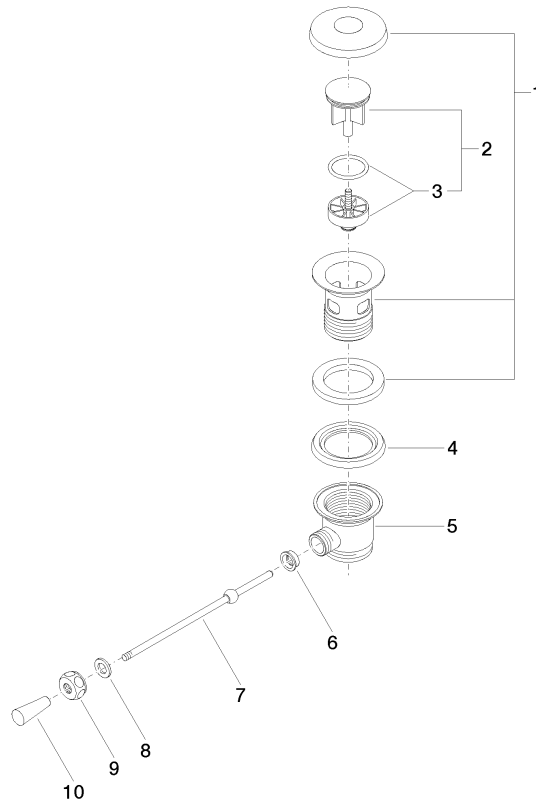

Ersatzteilstückliste

Nr.	Artikelnummer	Benennung	Verbaumenge	Lieferzeit
1	90 11 01 026 00-46	Kelch	1	30
2	04 31 20 016 00-46	Stopfen	1	-
Ersatzteil nicht mehr bestellbar, bitte bestellen Sie den Nachfolgeartikel				
3	04 28 10 026 00 90	Zubehoer	1	2
4	09 14 03 025 90	Dichtung	1	2
5	09 11 01 023-46	Kelch	1	60
6	09 14 05 040 90	Dichtung	1	2
7	09 31 09 055-46	Zugstange	1	30
8	09 30 11 049 90	Scheibe	1	2
9	09 23 30 003-46	Mutter	1	30
10	09 20 01 040-46	Griff	1	30